

Smarttray®

PERFORADA

By **SAMET**



LA EVOLUCIÓN INTELIGENTE

THE INTELLIGENT EVOLUTION



GARANTÍA SAMET
WARRANTY SAMET



VELOCIDAD
SPEED



SIMPLICIDAD
SIMPLICITY



SEGURIDAD
SAFETY



PROVISIÓN RÁPIDA
FAST PROVISION

 www.samet.com.ar





¿Quiénes somos?/ About us

SAMET es una compañía metalúrgica con certificación ISO-9001, líder en la fabricación de bandejas portacables y elementos para instalaciones eléctricas industriales.

SAMET is metallurgical company with ISO-9001 certification, leader in the manufacture of cable trays and elements for industrial electrical installations.

Misión/Mission

Diseñar y producir canalizaciones eléctricas y productos eléctricos complementarios, aportando altos niveles de calidad, diseño y cuidado con en el medio ambiente, capacitando y apoyando a nuestro plantel de colaboradores, incorporando valor agregado, para generar rentabilidad y crecimiento a toda la cadena de valor.

Desing and produce cable trays, as well as componentes for industrial electrical installations, providing high quality standards, and environmental care, training and supporting our team, adding aggregate value to generate a growing profit compay and as a consequence, to develop our value chain.

Visión/Vision

Ser líderes latinoamericanos en diseño y fabricación de canalizaciones eléctricas y productos complementarios.

To be latinoamerican leaders, in the design and production of all type of cabel trays and complementary electric products.

samet
Líder en Bandejas Portacables



LOS 3 PILARES DE SMARTTRAY

Smartray Basis



SEGURIDAD

Safer

Menos riesgos para vos y los cables.

(Nearly) Riskless for cables and for you.



VELOCIDAD

Quicker

Sistema encastrable, permite un montaje 5 veces más rápido, sin cuplas ni accesorios extras.

Built-in system allows 5 times faster assemble, with no need extra.



SIMPLICIDAD

Simpler

Diseño simple y efectivo: Agiliza el montaje y facilita la instalación de cables y accesorios.

Straightforward and effective design that smoothens the installation. Piecing together time

Smarttray
Perforada By **samet**

SISTEMA TRADICIONAL

Traditional System

<p>TIEMPO DE UNIÓN Time</p>	15 seg.	75 seg.
<p>PRODUCTIVIDAD Productivity</p>	5X	1X
<p>MATERIALES POR UNIÓN Accessories used</p>	2 Juegos de bulonería Carriage bolt with nut	10 2 Cuplas splice plate 8 Juegos de bulonería 8 Carriage bolt with nut
<p>PESO DE MATERIALES POR UNIÓN Weight materials</p>	15 grs.	140 grs.
<p>CARGA DE TRABAJO ADMISIBLE Safe working load</p>	60 Kg/mts. Resultado para la unión de un sistema de dos bandejas smarttray perforada de ancho 300mm-chapa #22-0.71mm Experimental result based in the fitting of two 300mm wide 50mm height Smarttray cable trays Thinckness 0.71mm	30 Kg/mts. Resultado para la unión de un sistema de dos bandejas perforadas tradicionales de ancho 300mm chapa #20-0.89mm Experimental result based in the fitting of two 300mm wide-50mm height Traditional cable trays Thinckness 0.89mm
<p>PESO DE LA BANDEJA Cable tray weight</p>	6 Kg 25% MÁS LIVIANA!! 25%-Lighter	8 Kg

Todas las unidades de medida en esté catalogo están expresadas en mm.
All the dimensions at this catalogue are expressed in mm.

LAS VENTAJAS DE LA EVOLUCIÓN INTELIGENTE

THE ADVANTAGES OF OUR INTELLIGENT TRAY

SIN CUPLAS, SOLO 2 JUEGOS DE BULONERÍA

Con el exclusivo acople Smarttray solo bastan 2 juegos de bulonería M6 para unir de manera correcta, entre sí cualquier componente del sistema.



TAPA UNIVERSAL SMARTTRAY

Logra un encastre rápido, seguro y sin grampas, con las tapas Smarttray.

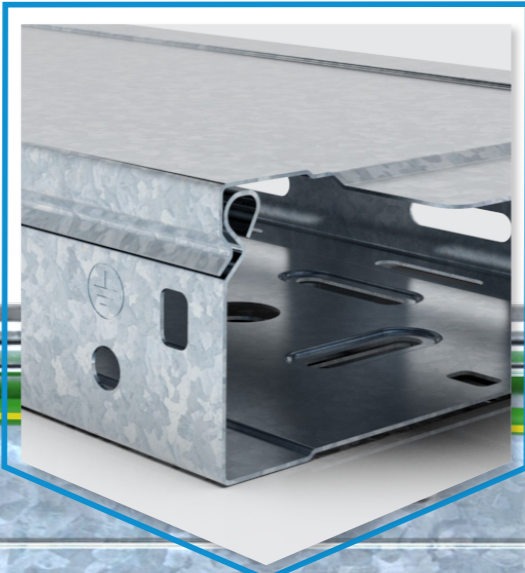

ALOJAMIENTO PARA GRAMPA EQUIPOTENCIAL

Alojamiento para una rápida y segura conexión equipotencial, con nuestra exclusiva grampa GFCE-B.

Según lo indicado por el Reglamento AEA90364

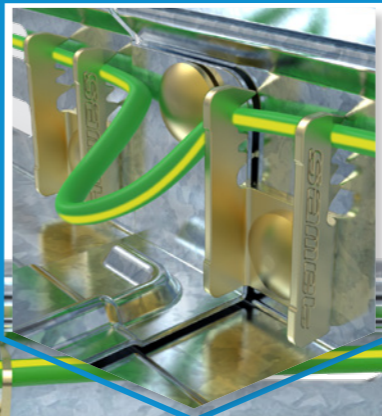

PROTECCIÓN DE CABLES Y REFUERZO DE LAS UNIONES

La nervadura inteligente de las bandejas Smarttray, permite una unión más fuerte y segura para los cables.

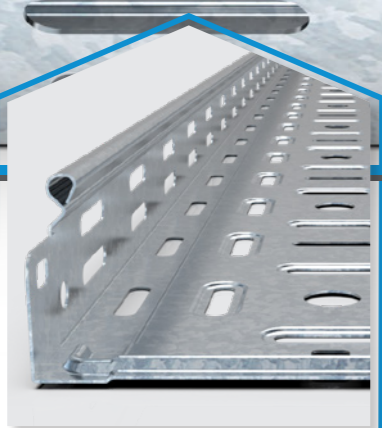
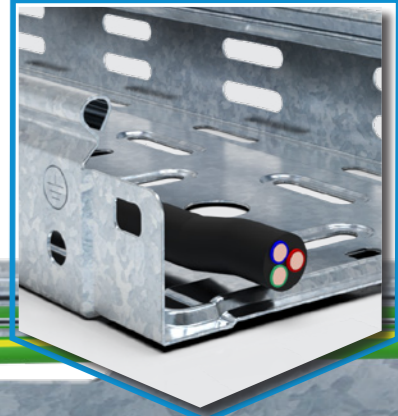

BORDES REDONDEADOS

Sin aristas filosas, para mayor protección de cables e instaladores.



MULTIPLICIDAD DE AGUJEROS LATERALES

Permiten montar con facilidad y rapidez una gran variedad de accesorios, a la vez que ayudan a una mayor ventilación.

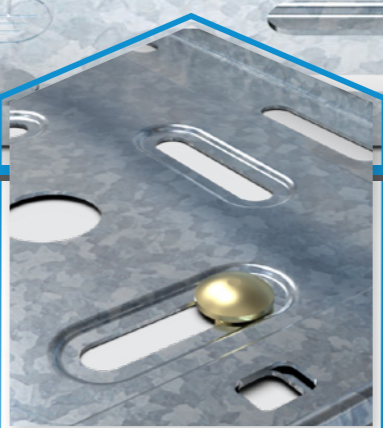

PERFORACIONES EMBUTIDAS

Para un mejor alojamiento de tornillos, con un mínimo contacto con los cables.

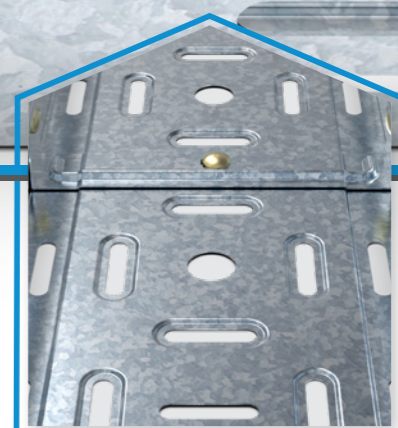

GRAN VARIEDAD DE PERFORACIONES

Permiten fijar y asegurar la bandeja a cualquier soporte maximizando a su vez la disipación de calor.



Producto distinguido con el Sello Buen Diseño argentino

Samet. S.A
Línea Smartray
Sello N° 2141



El Sello de Buen Diseño argentino es una distinción oficial que otorga el Ministerio de Producción a los productos de la industria nacional que se destacan por su innovación, por su participación en la producción local sustentable, por su posicionamiento en el mercado y por su calidad de diseño.

Busca fomentar y potenciar a todas aquellas Pymes y cooperativas argentinas, que mediante la incorporación de estrategias de diseño implementen mejoras en sus procesos industriales y en sus productos a fin de promover su competitividad.

TRAMO RECTO SMARTTRAY Cable Tray



ANCHO Width	CÓDIGO Ref. Cod	ESPESOR Thickness
50	TRPS-050-22-Z	0.71
100	TRPS-100-22-Z	0.71
150	TRPS-150-22-Z	0.71
200	TRPS-200-22-Z	0.71
300	TRPS-300-22-Z	0.71
450	TRPS-450-20-Z	0.89
600	TRPS-600-20-Z	0.89

LARGO NOMINAL : 3000 mm
Normal Length: 3000 mm

EL PASO A PASO Step by step



1

UNIÓN DE BANDEJAS

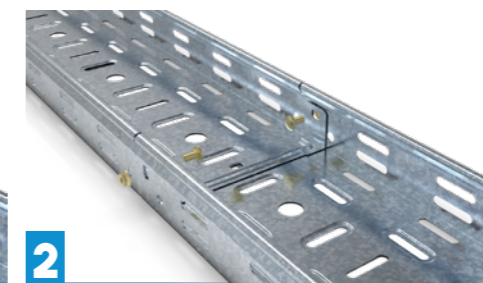

2

Smarttray piecing togheter

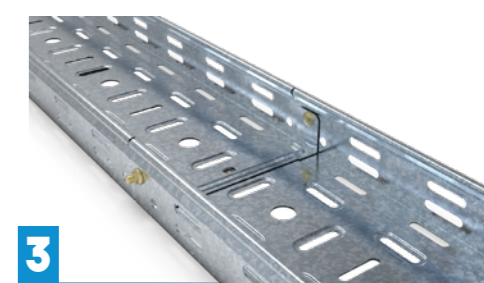

3



1

COLOCACIÓN DE TAPAS



2

Smarttray cover fitting



3

**MONTAJE MÁS RÁPIDO
SIN CUPLAS, NI GRAMPAS !!!**



CURVA ESLABONADA SMARTTRAY

Smarttray Articulated Bend

ANCHO Width	CÓDIGO Ref.Cod	ESPESOR Thickness	ESLABÓN UNIVERSAL Universal Link
50	EPS-050-Z	0.71	
100	EPS-100-Z	0.71	
150	EPS-150-Z	0.71	
200	EPS-200-Z	0.71	
300	EPS-300-Z	0.71	
450	EPS-450-Z	0.89	
600	EPS-600-Z	0.89	

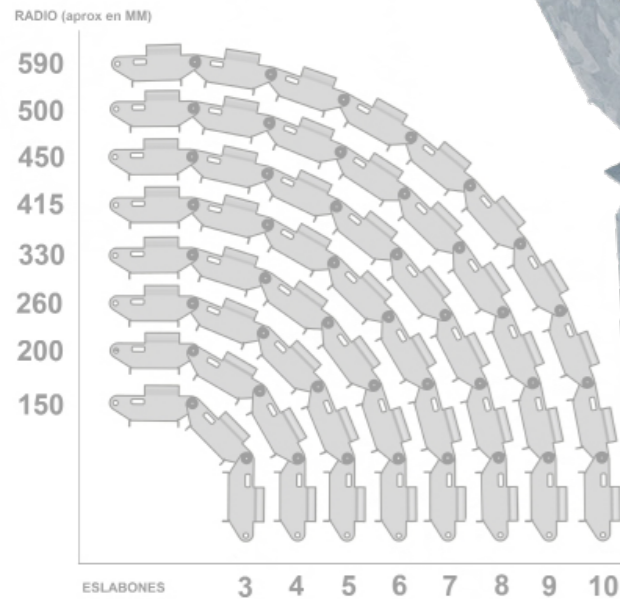
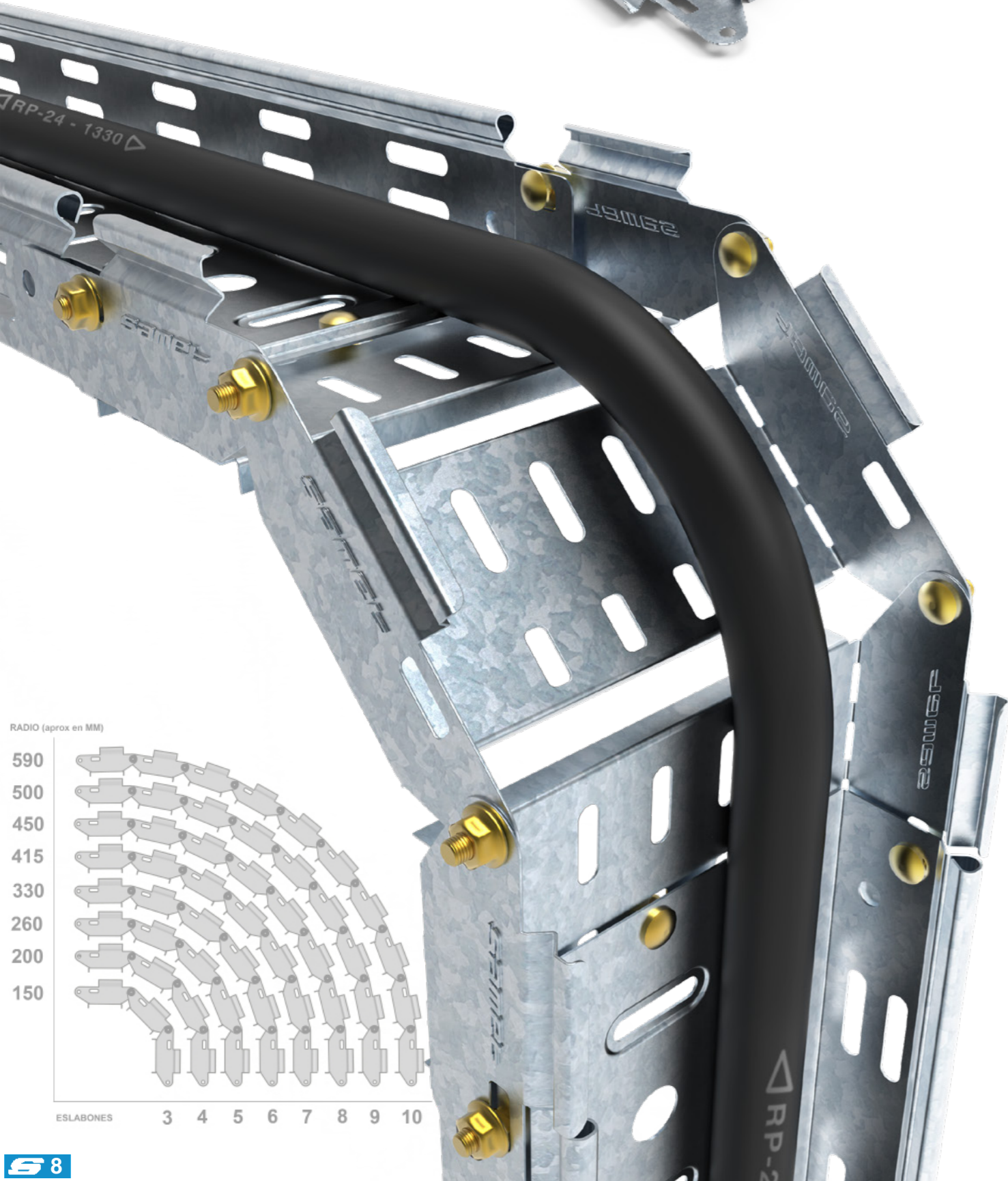
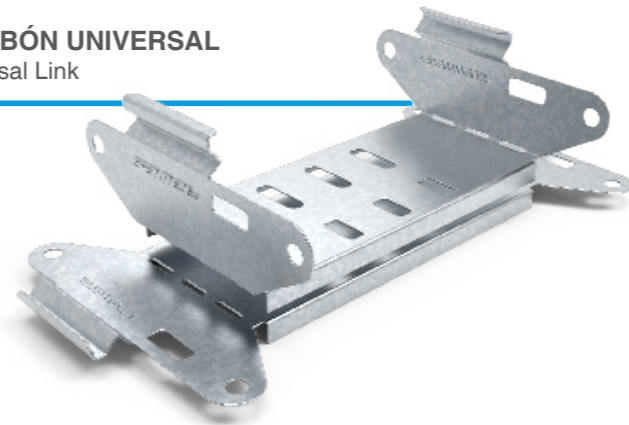

CURVAS

Elbows

CURVA PLANA A 90° Elbow 90°

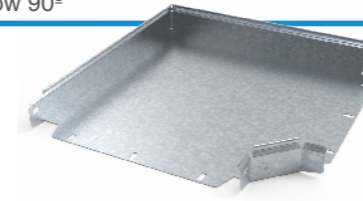

ANCHO Width	CÓDIGO Ref.Cod	ESPESOR Thickness
50	CPS-050-90-Z	0.71
100	CPS-100-90-Z	0.71
150	CPS-150-90-Z	0.71
200	CPS-200-90-Z	0.71
300	CPS-300-90-Z	0.71
450	CPS-450-90-Z	0.89
600	CPS-600-90-Z	0.89

CURVA PLANA A 45° Elbow 45°

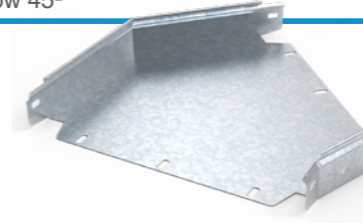

ANCHO Width	CÓDIGO Ref.Cod	ESPESOR Thickness
50	CPS-050-45-Z	0.71
100	CPS-100-45-Z	0.71
150	CPS-150-45-Z	0.71
200	CPS-200-45-Z	0.71
300	CPS-300-45-Z	0.71
450	CPS-450-45-Z	0.89
600	CPS-600-45-Z	0.89

CURVA VERTICAL ASCENDENTE Vertical Inside Elbow

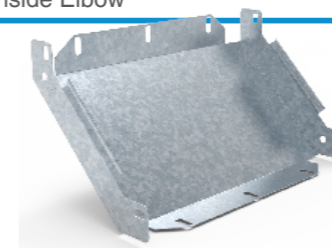

ANCHO Width	CÓDIGO Ref.Cod	ESPESOR Thickness
50	CUPS-050-A-Z	0.71
100	CUPS-100-A-Z	0.71
150	CUPS-150-A-Z	0.71
200	CUPS-200-A-Z	0.71
300	CUPS-300-A-Z	0.71
450	CUPS-450-A-Z	0.89
600	CUPS-600-A-Z	0.89

CURVA VERTICAL DESCENDENTE Vertical Outside Elbow



ANCHO Width	CÓDIGO Ref.Cod	ESPESOR Thickness
50	CUPS-050-D-Z	0.71
100	CUPS-100-D-Z	0.71
150	CUPS-150-D-Z	0.71
200	CUPS-200-D-Z	0.71
300	CUPS-300-D-Z	0.71
450	CUPS-450-D-Z	0.89
600	CUPS-600-D-Z	0.89

UNIONES

Unions

UNIÓN T Horizontal Tee

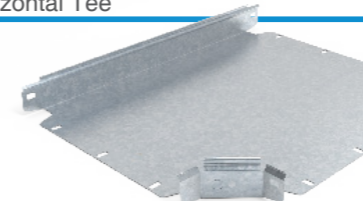

ANCHO Width	CÓDIGO Ref.Cod	ESPESOR Thickness
50	TPS-050-Z	0.71
100	TPS-100-Z	0.71
150	TPS-150-Z	0.71
200	TPS-200-Z	0.71
300	TPS-300-Z	0.71
450	TPS-450-Z	0.89
600	TPS-600-Z	0.89

UNIÓN CRUZ Horizontal Cross

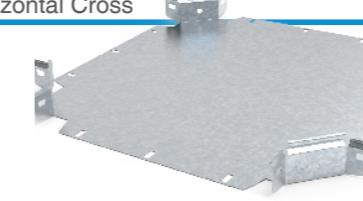

ANCHO Width	CÓDIGO Ref.Cod	ESPESOR Thickness
50	XPS-050-Z	0.71
100	XPS-100-Z	0.71
150	XPS-150-Z	0.71
200	XPS-200-Z	0.71
300	XPS-300-Z	0.71
450	XPS-450-Z	0.89
600	XPS-600-Z	0.89

EMBUDO PARA BAJADA EN FORMA PERPENDICULAR
Crosswise Vertical Tee Down



ANCHO Width	CÓDIGO Ref.Cod	ESPEJOR Thickness
50	EMTS-050-Z	0.71
100	EMTS-100-Z	0.71
150	EMTS-150-Z	0.71
200	EMTS-200-Z	0.71
300	EMTS-300-Z	0.71
450	EMTS-450-Z	0.89
600	EMTS-600-Z	0.89

EMBUDO PARA BAJADA EN FORMA PARALELA
Lengthwise Vertical Tee Down

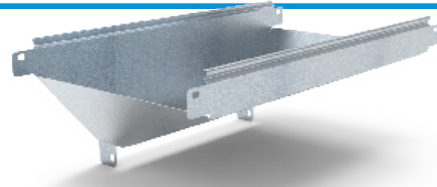

ANCHO Width	CÓDIGO Ref.Cod	ESPEJOR Thickness
50	EMPS-050-Z	0.71
100	EMPS-100-Z	0.71
150	EMPS-150-Z	0.71
200	EMPS-200-Z	0.71
300	EMPS-300-Z	0.71
450	EMPS-450-Z	0.89
600	EMPS-600-Z	0.89

DERIVACIÓN COMÚN
Extension Horizontal Tee



ANCHO Width	CÓDIGO Ref.Cod	ESPEJOR Thickness
50	DCPS-050-Z	0.71
100	DCPS-100-Z	0.71
150	DCPS-150-Z	0.71
200	DCPS-200-Z	0.71
300	DCPS-300-Z	0.71
450	DCPS-450-Z	0.89
600	DCPS-600-Z	0.89

DERIVACIÓN UNIVERSAL
Universal extension Horizontal Tee



CÓDIGO Ref.Cod
DUPS-Z

FINAL DE TRAMO-REDUCCIÓN
Blind end-Offset reducing splice plate



ANCHO Width	CÓDIGO Ref.Cod	ESPEJOR Thickness
25	RFPS-025-Z	0.71
50	RFPS-050-Z	0.71
75	RFPS-075-Z	0.71
100	RFPS-100-Z	0.71
150	RFPS-150-Z	0.71
200	RFPS-200-Z	0.71
300	RFPS-300-Z	0.71
450	RFPS-450-Z	0.89
600	RFPS-600-Z	0.89

ACOMETIDA PARA TABLERO
Box Connector.



ANCHO Width	CÓDIGO Ref.Cod	ESPEJOR Thickness
50	ACPS-050-Z	0.71
100	ACPS-100-Z	0.71
150	ACPS-150-Z	0.71
200	ACPS-200-Z	0.71
300	ACPS-300-Z	0.71
450	ACPS-450-Z	0.89
600	ACPS-600-Z	0.89

SOPORTE MÉNSULA
Wall Bracket



ANCHO Width	CÓDIGO Ref.Cod
130	S-130-Z
180	S-180-Z
230	S-230-Z
330	S-330-Z

SOPORTE MÉNSULA REFORZADA
Wall Bracket, Heavy duty



ANCHO Width	CÓDIGO Ref.Cod
130	SR-130-G
180	SR-180-G
230	SR-230-G
330	SR-330-G
480	SR-480-G
630	SR-630-G

SOPORTE SIMPLE
Overhead Hanger



ANCHO Width	CÓDIGO Ref.Cod
60	SS-050-G
110	SS-100-G

GRAMPA DE SUSPENSIÓN P/ BANDEJA PERFORADA
Central Hanger



ANCHO Width	CÓDIGO Ref.Cod
60	GSP-050-G
110	GSP-100-G
160	GSP-150-G
210	GSP-200-G

SOPORTE UNIVERSAL SMARTTRAY
Universal Smarttray Support



ANCHO Width	CÓDIGO Ref.Cod
50	SUS-050-Z
100	SUS-100-Z
150	SUS-150-Z
200	SUS-200-Z
300	SUS-300-Z

SOPORTE ÁNGULO REGULABLE
Regulable Wall Bracket

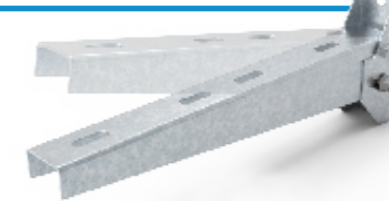

ANCHO Width	CÓDIGO Ref.Cod
200	SAR-150-Z
250	SAR-200-Z
370	SAR-300-Z

SOPORTE BAJO PISO
Floor Bracket

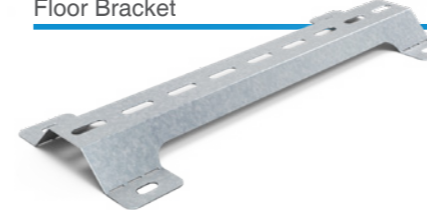

ANCHO Width	CÓDIGO Ref.Cod
50-150	SBP-050/150-Z
150-300	SBP-150/300-Z
300-600	SBP-300/600-Z

SOPORTE TRAPECIO
Trapeze Hanger



ANCHO Width	CÓDIGO Ref.Cod
200	ST-150-Z
250	ST-200-Z
350	ST-300-Z
500	ST-450-Z
650	ST-600-Z

SOPORTE CAJA UNIVERSAL SMARTTRAY
Universal Smarttray Mounting Plate

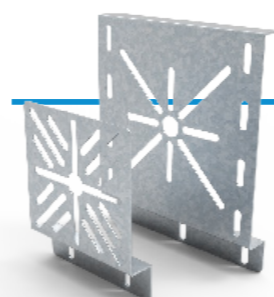

DIMENSIONES. Dimensions	CÓDIGO Ref.Cod
190x190	SCUS-190-Z
130x125	SCUS-130-Z

SOPORTE CAJA UNIVERSAL SMARTTRAY CON ENTRADA P/ PRENSACABLE
Universal Smarttray Mounting Plate with cable gland enter



DIMENSIONES. Dimensions	CÓDIGO Ref.Cod
130x125	SCUSP-130-Z

ACCESORIOS COMPLEMENTARIOS

Accessories

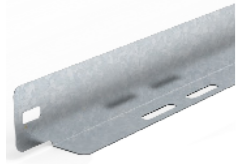

BANDA DIVISORIA
Barrier Strip

CÓDIGO
Ref.Cod **BDS01Z**



UNIÓN LATERAL INTELIGENTE
Intelligent Splice Plate

CÓDIGO
Ref.Cod **ULSZ**



GRAMPA DE FIJACIÓN EQUIPOTENCIAL
Grounding Clamp

CÓDIGO
Ref.Cod **GFCE-B**
Incluye Bulonería
Empaque por 100 Unidades
Patente pendiente-N° 20170103023



JUEGO DE BULONERÍA M6
M6 Carriage Bolt with Nut

CÓDIGO
Ref.Cod **JB-CC-M6**
Empaque por 100 Unidades



TUERCA RETEN+TORNILLO PARA UNIÓN DE TAPA
Nut Retainer+Bolt

CÓDIGO
Ref.Cod **JB-TRUST-M6**
Empaque por 100 Unidades

TAPAS

Covers

TAPA CIEGA PARA TRAMO RECTO
CableTray-Cover



ANCHO	CÓDIGO	ESPESOR
Width	Ref.Cod	Thickness
50	TTRS-050-22-Z	0.71
100	TTRS-100-22-Z	0.71
150	TTRS-150-22-Z	0.71
200	TTRS-200-22-Z	0.71
300	TTRS-300-22-Z	0.71
450	TTRS-450-20-Z	0.89
600	TTRS-600-20-Z	0.89

TAPA CURVA A 90°
Cover for 90°elbow

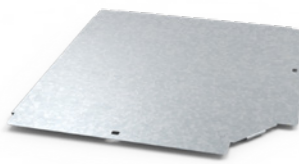

ANCHO	CÓDIGO	ESPESOR
Width	Ref.Cod	Thickness
50	TCPS-050-90-Z	0.71
100	TCPS-100-90-Z	0.71
150	TCPS-150-90-Z	0.71
200	TCPS-200-90-Z	0.71
300	TCPS-300-90-Z	0.71
450	TCPS-450-90-Z	0.89
600	TCPS-600-90-Z	0.89

TAPA CURVA A 45°
Cover for 45°elbow



ANCHO	CÓDIGO	ESPESOR
Width	Ref.Cod	Thickness
50	TCPS-050-45-Z	0.71
100	TCPS-100-45-Z	0.71
150	TCPS-150-45-Z	0.71
200	TCPS-200-45-Z	0.71
300	TCPS-300-45-Z	0.71
450	TCPS-450-45-Z	0.89
600	TCPS-600-45-Z	0.89

TAPA DE UNIÓN T
Cover for Horizontal Tee

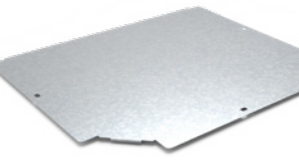

ANCHO	CÓDIGO	ESPESOR
Width	Ref.Cod	Thickness
50	TTPS-050-Z	0.71
100	TTPS-100-Z	0.71
150	TTPS-150-Z	0.71
200	TTPS-200-Z	0.71
300	TTPS-300-Z	0.71
450	TTPS-450-Z	0.89
600	TTPS-600-Z	0.89

TAPA DE UNIÓN CRUZ
Cover for Horizontal Cross



ANCHO	CÓDIGO	ESPESOR
Width	Ref.Cod	Thickness
50	TXPS-050-Z	0.71
100	TXPS-100-Z	0.71
150	TXPS-150-Z	0.71
200	TXPS-200-Z	0.71
300	TXPS-300-Z	0.71
450	TXPS-450-Z	0.89
600	TXPS-600-Z	0.89

TAPA P/ CURVA VERTICAL
Cover for Universal link



ANCHO	CÓDIGO	ESPESOR
Width	Ref.Cod	Thickness
50	TCUPS-050-D-Z	0.71
100	TCUPS-100-D-Z	0.71
150	TCUPS-150-D-Z	0.71
200	TCUPS-200-D-Z	0.71
300	TCUPS-300-D-Z	0.71
450	TCUPS-450-D-Z	0.89
600	TCUPS-600-D-Z	0.89

TAPA DE ESLABÓN UNIVERSAL
Cover for Universal link



ANCHO	CÓDIGO	ESPESOR
Width	Ref.Cod	Thickness
50	TEPS-050-Z	0.71
100	TEPS-100-Z	0.71
150	TEPS-150-Z	0.71
200	TEPS-200-Z	0.71
300	TEPS-300-Z	0.71
450	TEPS-450-Z	0.71
600	TEPS-600-Z	0.71

Para solicitar una tapa de curva ascendente, reemplazar la letra D presente en el código por una A.

APLICACIONES DESTACADAS

Featured Applications

UNIÓN LATERAL INTELIGENTE: Conocé los tres usos con estas imágenes.

Intelligent Splice Plate: Discover the 3 different applications.

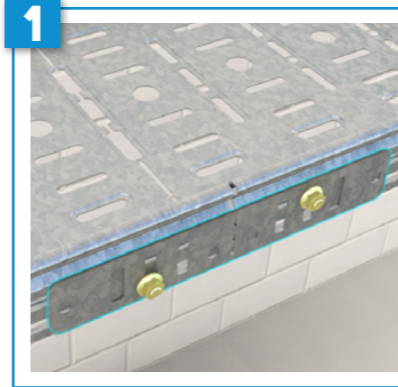

Tramo con tramo.
Use the splice plate to join a piece of cable tray with a full cable tray.

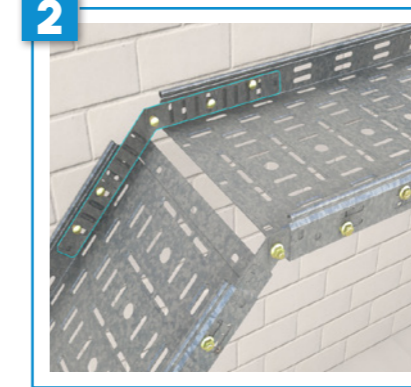

Cambios de nivel usando dos de ellas.
By joining two splice plates you can a change of level .

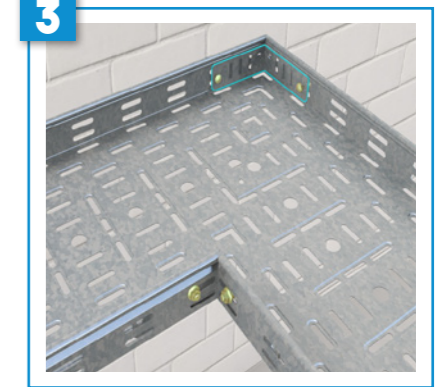

Su troquel permite realizar curvas según el ángulo requerido.
The splice plate allows you to improvize different elbows.

DERIVACIÓN UNIVERSAL : Una pieza para todas las medidas.

Universal extension horizontal tee: Chose the measure you need.

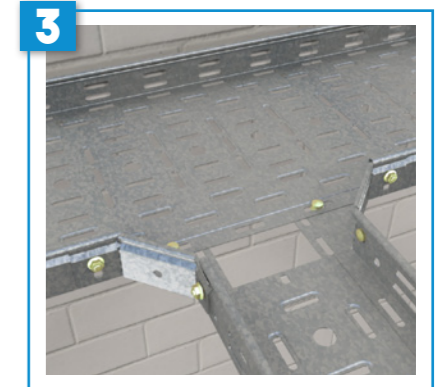
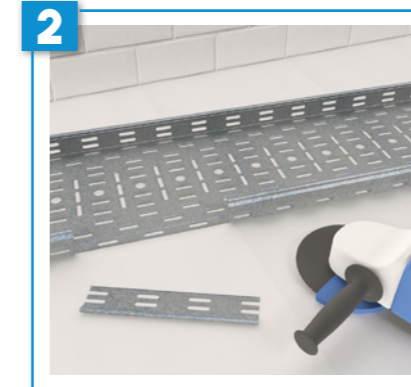
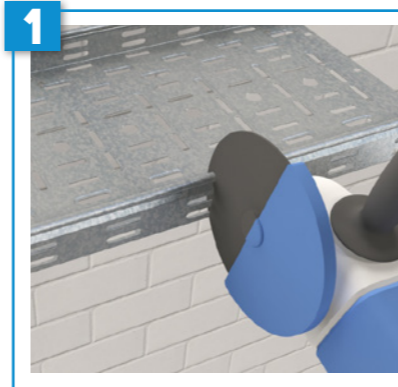

ESLABONES UNIVERSALES PARA CURVAS ARTICULADAS.

Universal link for articulated vertical bend.

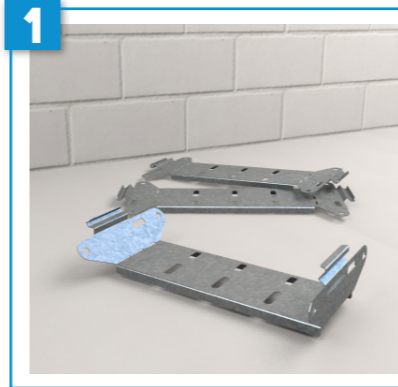

Sin diferencia entre extremos e intermedios.
No difference between endings or beginnings.

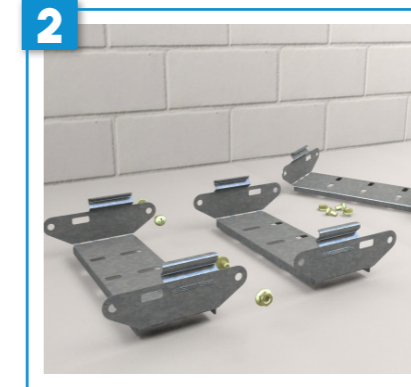

Misma bulonería que las bandejas y accesorios.
Same bolts and nuts used in cable trays.

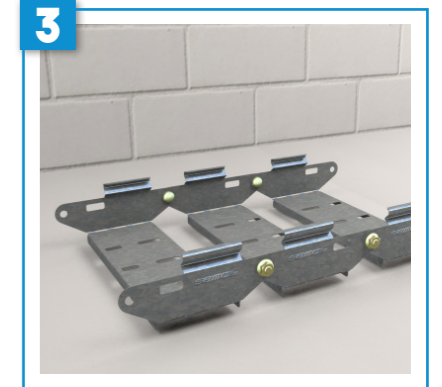

Armá la curva con la cantidad que requiera la instalación.
Add or take links to build a personalized vertical bend.

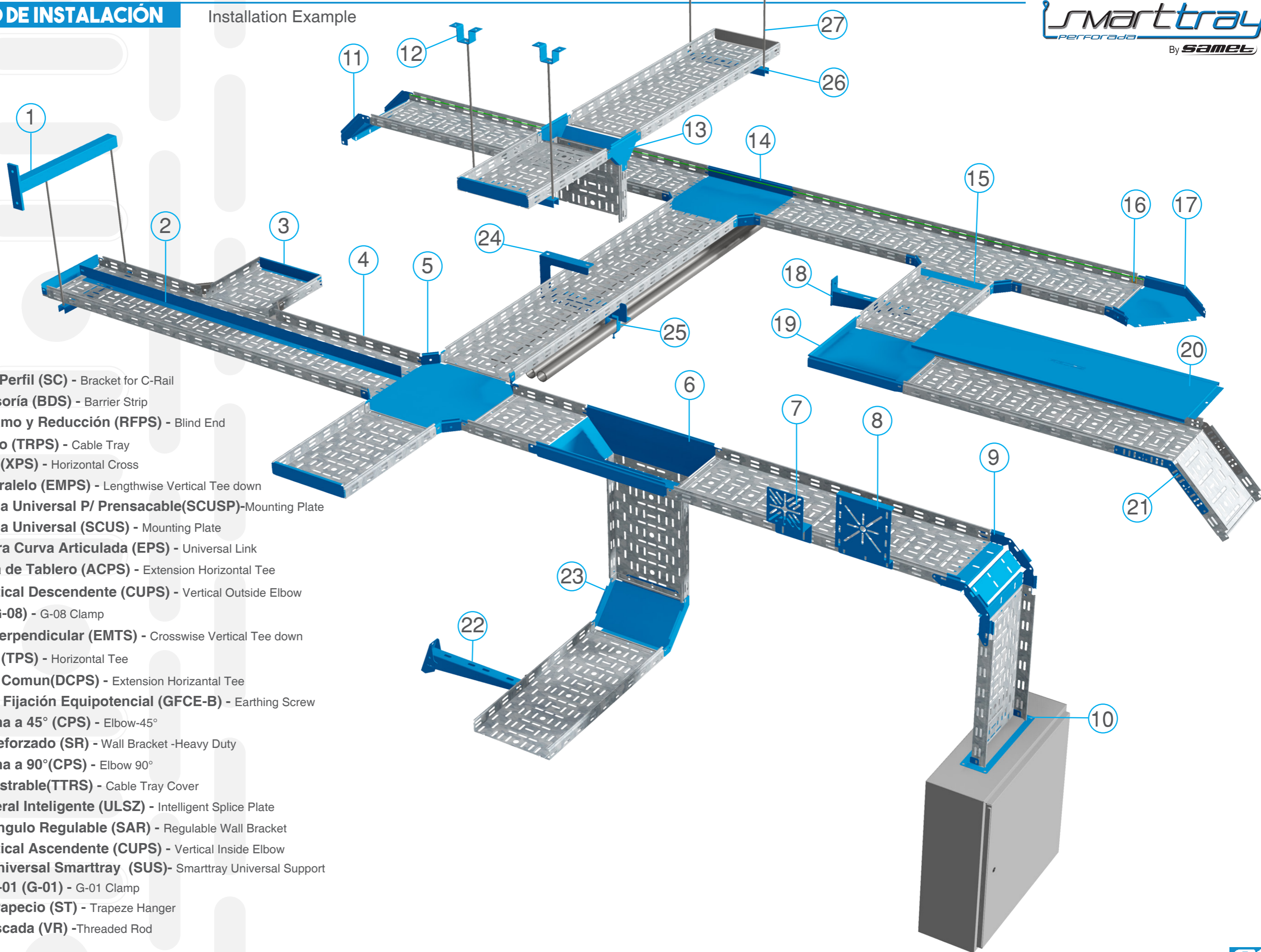

1. Soporte de Perfil (SC) - Bracket for C-Rail
2. Banda Divisoria (BDS) - Barrier Strip
3. Final de Tramo y Reducción (RFPS) - Blind End
4. Tramo Recto (TRPS) - Cable Tray
5. Unión Cruz (XPS) - Horizontal Cross
6. Embudo Paralelo (EMPS) - Lengthwise Vertical Tee down
7. Soporte Caja Universal P/ Prensacable(SCUSP)-Mounting Plate
8. Soporte Caja Universal (SCUS) - Mounting Plate
9. Eslabón para Curva Articulada (EPS) - Universal Link
10. Acometida de Tablero (ACPS) - Extension Horizontal Tee
11. Curva Vertical Descendente (CUPS) - Vertical Outside Elbow
12. Grampa (G-08) - G-08 Clamp
13. Embudo Perpendicular (EMTS) - Crosswise Vertical Tee down
14. Unión Tee (TPS) - Horizontal Tee
15. Derivación Común(DCPS) - Extension Horizontal Tee
16. Grampa de Fijación Equipotencial (GFCE-B) - Earthing Screw
17. Curva Plana a 45° (CPS) - Elbow-45°
18. Soporte Reforzado (SR) - Wall Bracket -Heavy Duty
19. Curva Plana a 90°(CPS) - Elbow 90°
20. Tapa Encastrable(TTRS) - Cable Tray Cover
21. Unión Lateral Inteligente (ULSZ) - Intelligent Splice Plate
22. Soporte Ángulo Regulable (SAR) - Regulable Wall Bracket
23. Curva Vertical Ascendente (CUPS) - Vertical Inside Elbow
24. Soporte Universal Smarttray (SUS)- Smarttray Universal Support
25. Grampa G-01 (G-01) - G-01 Clamp
26. Soporte Trapecio (ST) - Trapeze Hanger
27. Varilla Roscada (VR) -Threaded Rod

Smarttray®

LA EVOLUCIÓN INTELIGENTE



samet
der en Bandejas Portacabl



Ruta 24 N°1330 y Almafuerde,
Moreno.
(B1746MJN) Bs. As. - Argentina



Tel.: +54 237 - 4839000
Fax: +54 237 - 4839025



www.samet.com.ar



Samet s.a